

www.japanunix.com

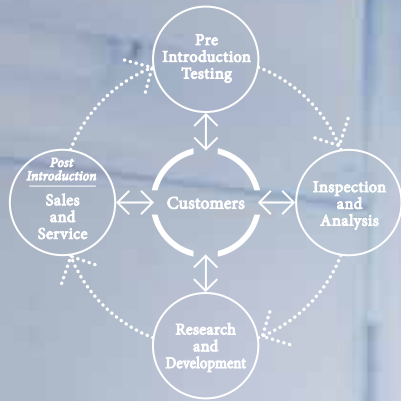

Technology Developing the Future, One Step at a Time

“By applying new ideas today, we hope to bring happiness and surprises to the world.”
Taking this feeling to heart, even if the difference means only an improvement of 0.1%,
we continuously strive to research and develop.
And so our technology evolves while we work with our customers
to make their dreams come true.



Soldering Support

At Japan Unix, we provide our customers with comprehensive support using a system that covers the full sales cycle of Pre-Introduction and continues with Post-Introduction/Sales and Service.

Joining the future

 JAPAN UNIX



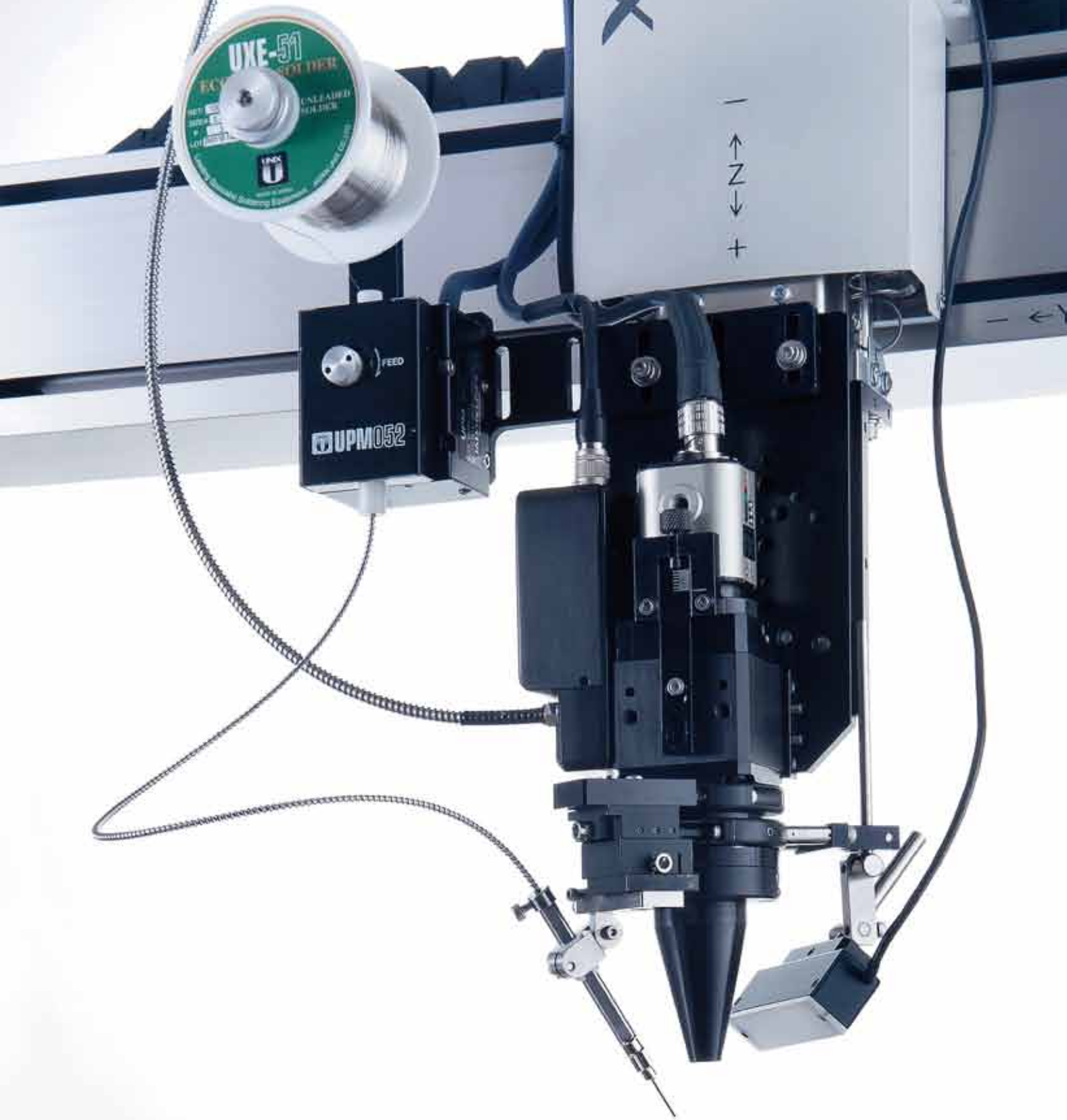

Japan Unix's Laser Soldering System

Streamlined soldering operations and higher quality are achieved simultaneously.

With many years spent in the pursuit of automated soldering technology, the original technology and service of Japan Unix come together to make high precision laser soldering a reality.

LASER SOLDERING SYSTEM vol.2

JAPAN UNIX LASER SOLDERING SYSTEM

5 STRENGTHS

p.04 | **1 ACTUAL USES**

For on-board electronics in vehicles, as well as mobile electronics, this technology plays an active role in cutting edge developments in a wide variety of fields.



p.06 | **2 ADVANTAGES**

Laser soldering has many advantages, when compared to more traditional methods.



p.08 | **3 STANDARD FUNCTIONAL**

Because of the special properties of lasers, it is possible to solder unusually parts with precision.



p.10 | **4 INSTALLATION METHODS**

With 3 basic installation methods, we can create a laser soldering structure to meet your needs.



p.12 | **5 OPTIONS**

Automatic laser soldering robots can be customized, making them even more user-friendly.

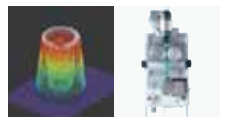

p.14 | **SPECIFICATIONS**

p.15 | **PRODUCT LIST**

p.16 | **PARTS LIST**

p.20 | **EXTERNAL VIEW DIAGRAM**

p.22 | **CUSTOMER SUPPORT**

At Japan Unix, we offer a comprehensive support system for our customers.



p.24 | **GLOBAL NETWORK**

• This catalog reflect the products as of September 2014. The product appearance and specifications can change without notice.

• Please carefully read through the instruction manuals enclosed with your products before use.

Laser Soldering Technology is used in a wide range of cutting edge applications.

Automotive Electronics

In recent years, modularization has been rapidly advancing. The electronic components in motor vehicles demand safety and high reliability, so the highest level of quality control in soldering is required. Through the use of non-contact laser soldering technology high quality and high productivity can be achieved.

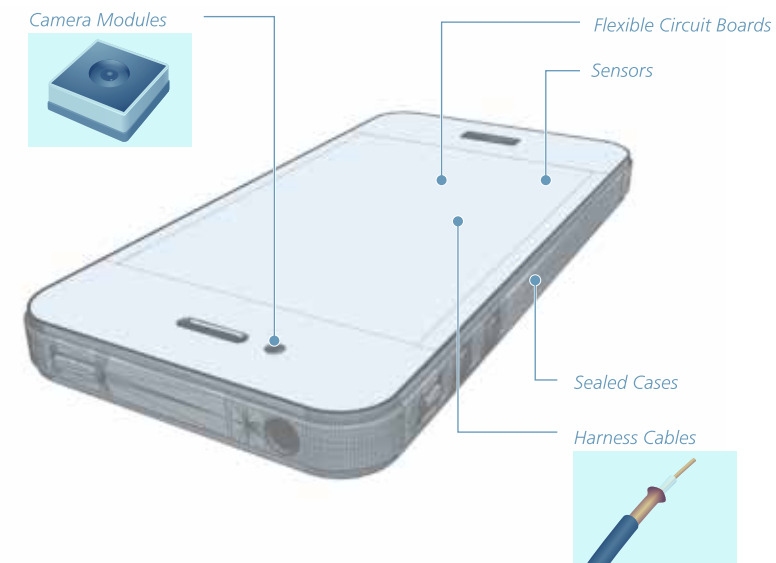
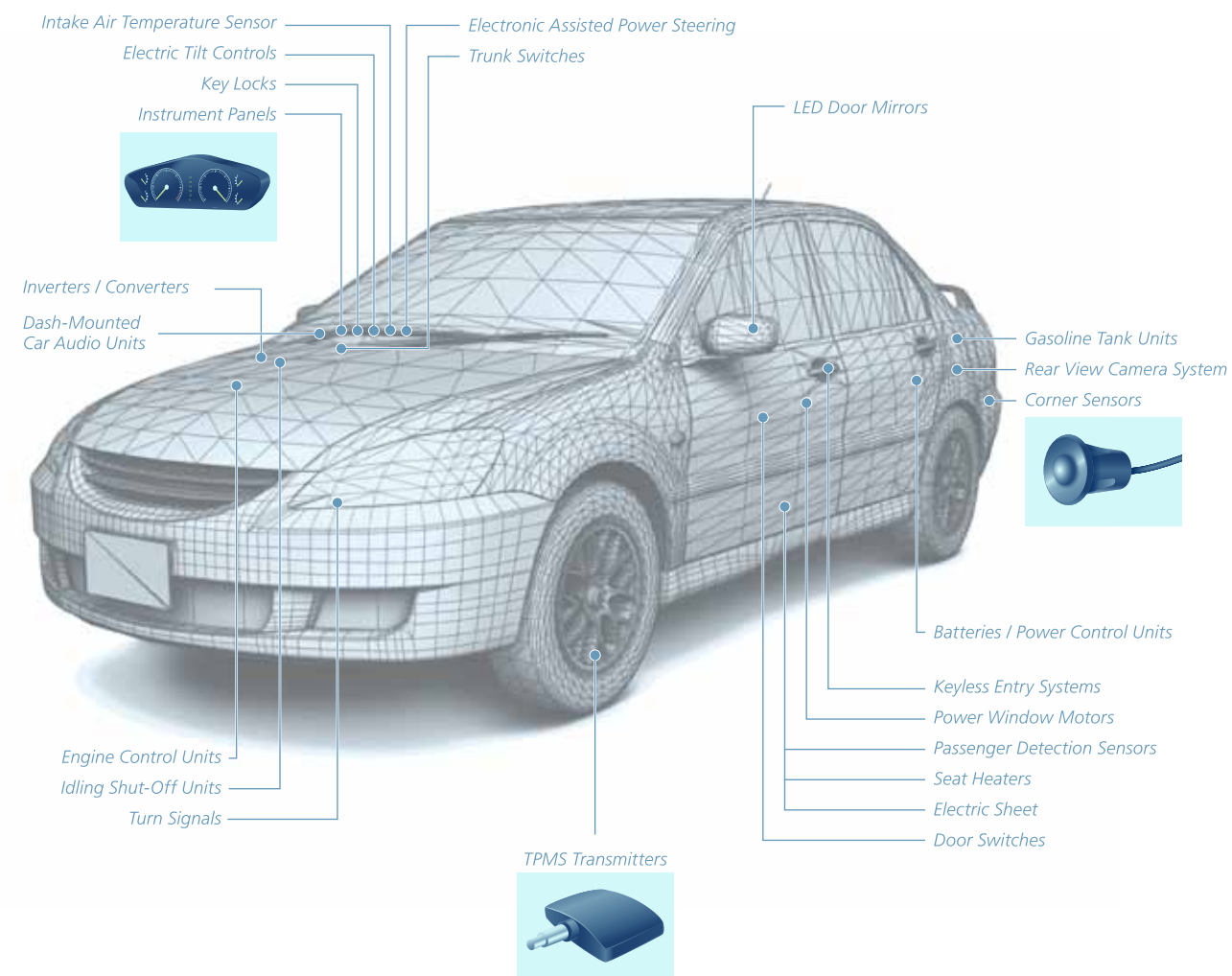

Smartphone

For smartphone and cellular phone applications, substrate boards are becoming more and more dense and efficient with slimmer, lighter weight designs in high demand. Because laser soldering is highly suitable for finely detailed applications, Laser Soldering Systems are frequently used in this field.

LED Terminals

Laser soldering is an ideal solution for constructing the terminal link and local heating elements of various LED light emitters. With techniques such as the use of divergent laser shots to simultaneously expose two separate points, laser soldering offers expanding possibilities.





Laser soldering is suitable for production of extremely fine-detailed parts.



Advantages of Laser Soldering

The heating principle differs between “laser soldering” and “iron-tip soldering.” At Japan Unix, our years of experience help us to advise our customers of the most appropriate heating techniques for their products and applications.

Product	 Laser Soldering	 Contact Tip Soldering
Heat Conversion	Surface Heating	Heat Transmission
Range of Heat Generation	Restrictive	Diffuse
Heating Time	Instantaneous	Slow
Temperature	Continuous temperature rise.	Limited temperature rise.
Advantages	<ul style="list-style-type: none"> • Suited to extremely detailed parts. • Enables soldering applications in narrow and complicated spaces. 	<ul style="list-style-type: none"> • Suitable for large thermal capacity components. • Temperature regulation during soldering is simple.

The Process of Laser Soldering

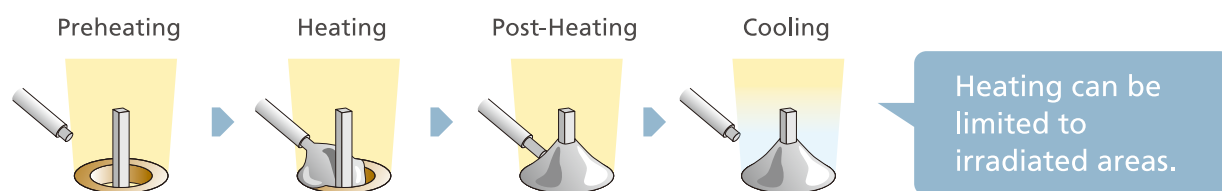

[Precautions during heating]
During laser soldering, in response to the absorption of a quantity of energy, sudden spikes in temperature may occur. Overheating may cause deterioration of strength and reliability of finished products.

Quality Control Support

Because the composition of solder changes depending on temperature conditions, if soldering is no performed at the appropriate temperature, reliable and durable solder joints cannot be achieved. At Japan Unix, we assist customers in smooth product creation through our complete support system.

Soldering Laboratory

We thoroughly support customers with the latest analytical tools from pre-facility inspection, to system installation and testing for future products.



Inspection of temperature related solder composition changes

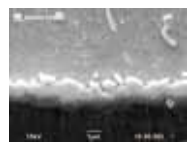

(SEM Survey)

Growth rates of intermetallic compounds related to temperature conditions

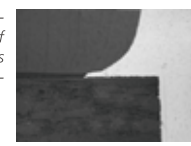

Confirm alloy structure and the state of substrate inner layers after completing soldering.

Laser system developed for soldering applications

Laser Head

The laser head condenses the laser light transmitted from the laser oscillator through the optical fiber of the appropriate size and exposes the selected area. A coaxial CCD camera is standard equipment on the laser head, and various other features to enhance the manufacturability.

[Internal structure of the laser head]

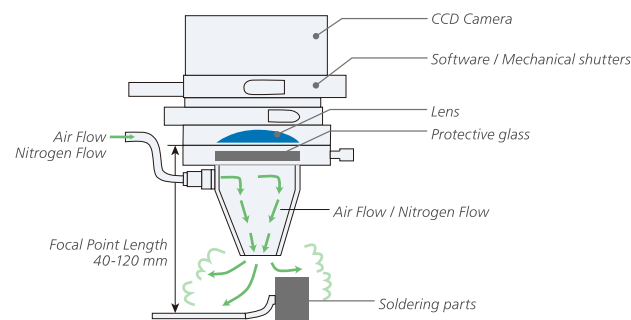

The structure of the area inside the laser head surrounding the optics is protected with an air jet. This prevents flux fumes from contaminating the optics. The CCD camera is set up in a coaxially to the optical components of the laser for a more compact construction.



Laser Controller / Oscillator

For laser soldering, controlling the laser output is extremely important. This critical output control is carried out by the controller. Also, the oscillator uses a fiber-coupling LD laser, and laser energy is transmitted to the head through optical fiber.

Model No.ULD-775 (ver.75W) consists of a controller (control section), oscillating section and driver. Our company's laser apparatus conforms to the standards of the International Electrotechnical Commission IEC60825-1:2007, as well as the Japan Industrial Standards JIS C 6802:2011. The laser class is class 4. Approved for export to the United States by the FDA.



The above equipment is Model No.ULD-746 (ver.30W-45W)

The ideal parameters can be easily setup to suit your working conditions.

Programs for 63 Waveform Patterns
Waveform Patterns

Laser waveform programs can be chosen from a maximum of 63 different patterns.



8 levels of energy power can be easily set up.
Energy Power

For 1 waveform, there are 8 different levels of energy output /time settings which can be easily assigned.



Selectable laser exposure position marks
Exposure position marks

On the monitor, the confirmation of laser shooting position can be set to either line type or square type.

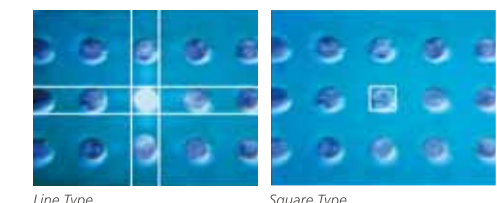

Safety features based on Class 4 laser standards
Software / Mechanical shutters

The laser emissions are isolated within the head. Operations can be carried out either through external signals controlled by a software system or mechanical system accessed by directly lowering the internal shutter by pressing a switch on the controller.



A stable condensation of light through smoke blocking
Sliding protective glass

The glass prevents flux fumes from entering the head and adversely affecting the laser condensing lens. Because of its sliding structure, the glass enables one-step insertion and removal, making for easy maintenance.

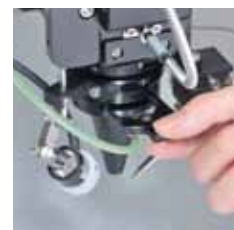

Laser exposure locations and finishing touches can be easily confirmed
The coaxial CCD camera is standard.

The coaxial camera enables monitoring confirmation of the soldering position making it simple to set up the area to be exposed to the laser.



Solder Feeder

The feeder provides the precise amount of solder to the joint area. It is equipped with an internal solder encoder that can accurately detect any trouble related to solder feeding.



(The solder feeder unit varies depending on the solder diameter used. ϕ 0.15 mm - ϕ 1.2 mm available.)

Soldering Controller

A controller governs the amount of solder feed as small as 0.1 mm increments with precise speed and timing.



3 different installation methods are available to suit your needs.

1 System Integration

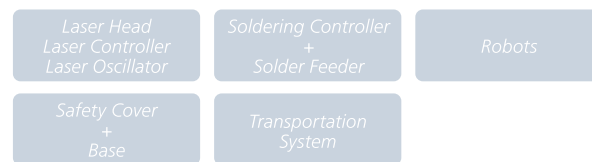

Our company is a one-stop shop for your laser soldering system needs, performing manufacturing line optimization, designing layouts in compliance with international safety regulations for lasers, and even carrying out construction and installation all in one place. Because we implement a comprehensive support service including setup of parameters by specialist engineers, we minimize the amount of time required by you, allowing you to focus on comprehensive management of your manufacturing lines. We offer a variety of production line support, including in-line, rotary table, and 2 slider systems.

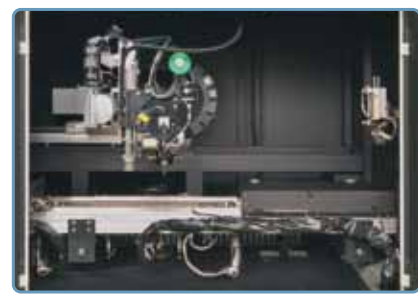

Inline System (Internal)



Inline System



Compact Inline System



Slider Type Offline System



Inline System



System for Components Loader and Insertion

2 Laser Soldering Robot

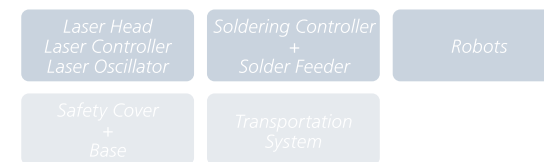

We will supply our original soldering robot equipped with a laser system. If you're looking for consolidated machinery with a record of achievement in soldering, look no further. Our support services include parameter setting by experienced engineers; you can do your work with peace of mind.

<Examples>



Desktop Laser Soldering Robot



Multiple Axis Laser Soldering Robot

•Any other requirements not included with our robots or options, such as safety cover, we ask our customers to please prepare and install these on their own.
•Some options, such as image processing systems, can be added on.

3 Laser Soldering Units

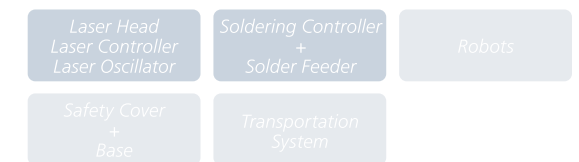

This unit is the best choice for companies that want to install only the core soldering components and develop overall production system by themselves, including frames, axles, and robots. It is also good for customers who already own soldering robots and would like them equipped with laser soldering units, so that they can then be used as laser soldering robots. Moreover, professional support such as parameter setting by experienced engineers can be offered for system development.



Laser Controller & Laser Oscillator



Laser Head



Soldering Controller

•This is the sale of only a laser soldering unit. Any additional requirements must be supplied by the customer.
•Some optional equipment may also be added.
•For safety covers and other requirements not included with our units or options, please prepare separately.

Laser Soldering Systems



In this set up of the 3 component laser system, the controller regulates laser output, the laser oscillator manages laser oscillation, and the laser head controls the exposure and positioning through the CCD camera.



In laser soldering, management of the solder amount is crucial. High precision feeder and controller units manage a steady amount of solder.



All of soldering robots at Japan Unix can be equipped with laser soldering units. The appropriate robot for your manufacturing line can be selected from our varied lineup of robots, which includes desktop models and scalar type models, among others.

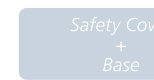

To prevent laser light leaking and to maintain a safe soldering process, it is necessary to conduct soldering operations within a carefully designed cabinet. With consideration for your manufacturing line, we provide specially designed safety covers and frames for maximizing both safety and operating efficiency.



We offer pallet systems design and others work holders in order to ensure effective transportation within the manufacturing line both before and after soldering processes. (Conveyor belts, index tables, etc.)

A wide variety of add-on options for more complete quality control

Options for Laser Systems

*Depending on robot types, some options may not be possible.
*Some options can be used only for customers purchasing core soldering units.

Atypical Laser Output

By changing the exposure shape of the laser, soldering can be applied to uniquely shaped circuit boards or components.

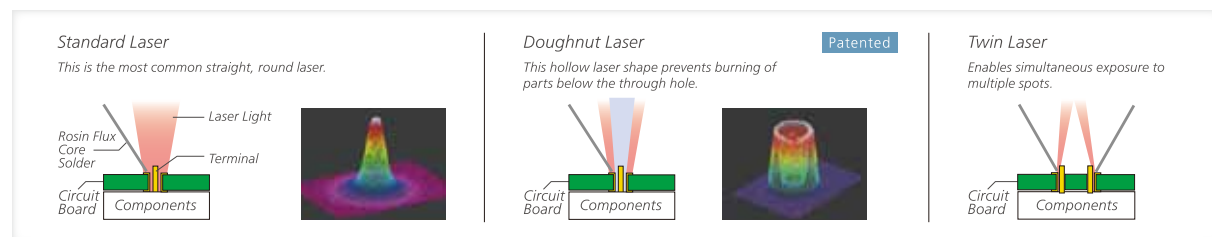

Power Meter

Measures and regulates the output of the laser, which is crucial for maintaining stable soldering quality.

LED Lighting

Lighting equipment to monitor for program teaching and make image processing easier. Choose the best shape for your working environment. (Available in spot, ring or bar light.)



Image Position Correction (Vision Sensor)

Detects solder supply and laser exposure locations, and automatically corrects for slippage in XY orientation of working operations. Image processing which identifies simple defectives is also possible.



*This option is only available for full integration systems using Japan Unix brand robots.

Pyrometer

The sensor captures real time temperature data during soldering. With our full integration systems, graphs of temperature data can be saved, and measured values can be output with CVS files.



*The temperature of pyrometer is easily affected by surface conditions, thus, the data is used as reference rather than a traceable temperature measurement.

Simple AOI Functions

Vision sensor supports the identification and judgment of defective products after the soldering operation.

*Because of a simple judgment function, depending on the work, it may not be able to achieve recognition. Japan Unix can perform tests to determine whether or not the system is suitable for customers' objectives.
*This option is only available for full integration systems using Japan Unix brand robots.

Height Correction

A Z-axis sensor corrects for irregularity in the height and the orientation of the solder position.

Add-on Options for Soldering Mechanical Section

Clean Cut Feeder (CCF)

Patent pending for

CCF cuts notches in solder during feeding which drastically prevents flux explosions. Patented two blade mechanism stabilizes rewind operation and prevents slippage.



Precision Solder Feeder

The innovative feeder can supply even superfine solder with diameters of $\phi 0.15$ - $\phi 1.2$, making it the perfect feeding device for use with laser soldering for fine-detailed parts. It uses an encoder that detects solder blockages and breaks.



Precision Needle

A needle suited for precision solder feeder is necessary when precise volume management is required, such as in fine-detailed solder wire.



*Please see this catalog parts table for more details about model numbers.

Lock-on Mechanism

The lock-on fixes solder supply position with a graduated angled block that prevents slippage during operation and maintenance. Resetting the position after maintenance is also performed with ease.

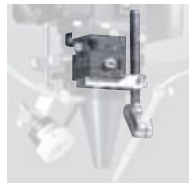

Air Curtain

By creating an air curtain in the areas of laser exposure and at the edge of the solder supply, flux fume dispersal is prevented which protects the laser head.

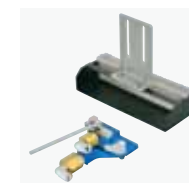

Tracing Mechanism for Solder Supply and Position

This is a mechanism for confirming that the solder supply position has been set up correctly.



Nitrogen Gas Generator

Non-electric generator produces nitrogen environment around work the area, improving the operational efficiency of lead-free solder. By inhibiting oxidation, the application of nitrogen improves solder wettability and spread. Additionally this also protects the Laser optics.



U Lock

This is a cap which attaches to the solder bobbin when installing a roll of solder. This allows removal and replacement of a new roll of solder with oneeasy click.





SPECIFICATIONS

Laser Soldering Unit



The picture shows Model No.ULD-746.

Model No.	ULD-746	ULD-775	
Laser power (rated)	30W•45W	75W	
Wavelength	Can select from 2 wavelengths		
Laser spot diameter (mm)	φ0.4-, φ0.6- (Min.φ0.2 is available as an option)	φ0.4-, φ0.6-	
Laser focal distance (mm)	Standard 60/ 30, 40, 80, 100 or 120 can be selected as an option		
Number of laser pulse	63	112	
Shutter	Software operated shutter ※1		
Fiber length	3m※2		
Laser positioning method	Coaxial measurement using a CCD camera		
Cooling method	Forced-air cooled		
Operating conditions	Environmental temperature: 10-40°C Humidity: 80% or less (no congelation)		
Power supply (voltage)	Single phase 220V±10% 50/60Hz	Multi-voltage	
Power consumption	1200VA	Max 1500VA (Driver) + 15VA (Controller)	
External dimensions	Driver	-	430 (W) ×132 (H) ×332 (D) mm
	Controller	331 (W) ×201 (H) ×465 (D) mm	300 (W) ×150 (H) ×310 (D) mm
	Oscillator	233 (W) ×210 (H) ×340 (D) mm	270 (W) ×160 (H) ×300 (D) mm
Weight	Driver	-	11.0kg
	Controller	17.5kg	6.5kg
	Oscillator	9kg	9.6kg
	Laser head	0.7kg	0.7kg
Safety standards Y	IEN class 4 label  Caution label  Explanation label		

※1 Can be changed to a mechanical shutter.
 ※2 5 m type is available through special order.



PRODUCT LIST

Laser Soldering Robots

Product Image	Name	Model No.	Remarks
	Desktop laser soldering robot	UNIX-412L-5PH1	Laser soldering unit + Triaxial desktop soldering robot (UNIX-412G) + solder feeder (UPM-052)
	Desktop laser soldering robot	UNIX-412L-5PH2	Laser soldering unit + Triaxial desktop soldering robot (UNIX-412G) + solder feeder (UPM-055)
	Desktop laser soldering robot	UNIX-413L-5PH1	Laser soldering unit + Triaxial desktop soldering robot (UNIX-413G) + solder feeder (UPM-052)
	Desktop laser soldering robot	UNIX-413L-5PH2	Laser soldering unit + Triaxial desktop soldering robot (UNIX-413G) + solder feeder (UPM-055)
	Multi-jointed laser soldering robot	UNIX-700HL	Laser soldering unit + SCARA soldering robot (UNIX-700H)

*Please contact us for more details. Custom orders are required for a frame or a cover, etc.

Laser Soldering Unit

Product Image	Model No.	Remarks
	ULD-746-30-02	A wavelength 30W Fiber φ0.2
	ULD-746-30-04	A wavelength 30W Fiber φ0.4
	ULD-746-30-06	A wavelength 30W Fiber φ0.6
	ULD-746-45-04	A wavelength 45W Fiber φ0.4
	ULD-746-45-06	A wavelength 45W Fiber φ0.6
	ULD-746S-30-02	B wavelength 30W Fiber φ0.2
	ULD-746S-30-04	B wavelength 30W Fiber φ0.4
	ULD-746S-30-06	B wavelength 30W Fiber φ0.6
	ULD-746S-45-04	B wavelength 45W Fiber φ0.4
	ULD-746S-45-06	B wavelength 45W Fiber φ0.6
	ULD-775-75-04	A wavelength 75W Fiber φ0.4
	ULD-775-75-06	A wavelength 75W Fiber φ0.6
	ULD-775S-75-04	B wavelength 75W Fiber φ0.4
	ULD-775S-75-06	B wavelength 75W Fiber φ0.6

*Please contact us for more details about specs, delivery time or else.

PARTS LIST

Laser Controller, Laser Oscillator

Laser Controller Battery

Model No.	Remarks
ULD-746-BAT	Made by Maxell: Red

Peltier

Product Image	Model No.	Remarks
	ULD-PT30	For 30W/45W (travel and service engineer cost would be charged.)

Fibers

Product Image	Model No.	Remarks
	ULD-FB-02	Fiber for $\phi 0.2$ (replaceable by customers) For both wavelength A & B, Length 3m
	ULD-FB-04	Fiber for $\phi 0.4$ (replaceable by customers) For both wavelength A & B, Length 3m
	ULD-FB-06	Fiber for $\phi 0.6$ (replaceable by customers) For both wavelength A & B, Length 3m

*5 m type is available through special order.
*Minimum Fiber Bending Radius : 200m

Laser Heads

Protective Glass

Product Image	Model No.	Remarks
	ULD-PG-SET-A	A wavelength protective glass (with drop prevention holder)
	ULDS-PG-SET-B	B wavelength protective glass (with drop prevention holder)
	ULD-PG	A wavelength protective glass (without drop prevention holder)
	ULDS-PG	B wavelength protective glass (without drop prevention holder)
	ULD-HLD-SET	Drop prevention holder only

Options



Shutters

Product Image	Name	Model No.	Remarks
	Shutter unit	ULD-STR	Mechanical shutter set

*The standard specification is a software shutter.

Options

LED Lighting

Product Image	Name	Model No.	Set Contents (Available for individual purchase)
 Spot type (Standard)	LED lighting set	ULD-LED	LED light (ULD-LED-L)/LED controller (ULD-LED-C)
 Bar type (custom)		 Ring type (custom)	

*Bar and Ring types are special order.

Laser Protective Eyeglasses



Model No.	Remarks
ULD-EP	For wavelength A
ULDS-EP	For wavelength B

Power Meter

Model No.	Remarks
ULD-PM-30S	For 30W laser diode
ULD-PM-50S	For 45W laser diode

Solder Feed Control Units

Soldering Controllers

Product Image	Name	Model No.	Remarks
 USC-881	Solder King V ^{※1}	USC-881	Integrated touch panel ^{※2}
 USC-881S		USC-881S	Separated touch panel ^{※2}

^{※1} Separate PC software available
^{※2} Desktop laser soldering robots are loaded with UPL-066 dedicated soldering controller units.

Solder Wire Heater Mechanism

Product Image	Model No.	Set Contents (Available for individual purchase)
	SHN-10-**	Temperature Controller (UHC-005) AC100V Heater (HN-S30-**) ** Heater Clamp (HN-CLP) Heater Cable (QN-MP4B)

*Not applicable to use with clean cut feeder **Solder Diameter

Nitrogen Gas Generator

Product Image	Model No.	Remarks
	UNX-200	Concentrated Nitrogen, Maximum 99.9%, 2L/min Dry Air 0.7MPa No Power Supply Required

Solder Feed Units

Solder Feeder

Product Image	Name	Model No.	Remarks
 UPM-052 UPM-055	Precision Solder Feeding Device (φ0.15-0.6mm)	UPM-052	With U lock Solder wire diameter specs: φ0.15/φ0.2/φ0.3/φ0.4/φ0.5/φ0.6/φ0.8 ^{※1} (The diameter cannot be changed after purchase.)
	Precision Solder Feeding Device (φ0.5-1.2)	UPM-055	With U lock Solder wire diameter specs: φ0.5/φ0.6/φ0.8/φ1.0/φ1.2
	Precision Solder Feeding Device, Clean Cut Type (φ0.5-1.2)	UPM-055CC	With U lock Solder wire diameter specs: φ0.5 ^{※2} /φ0.6/φ0.8/φ1.0/φ1.2

※1 Special Type
※2 Option: The 1 blade cutter for φ0.5.

Solder Feeder Spare Parts

Solder Feeder	Name	Model No.	Remarks
UPM-052	Input nozzle	UPM-052-INZ**	**=Wire diameter specs: φ0.15=015 φ0.15/φ0.2/φ0.3/φ0.4/φ0.5/φ0.6/φ0.8 ^{※1} (The diameter cannot be changed after purchase.)
	Center nozzle	UPM-052-CNZ**	
	Output nozzle	UPM-052-ONZ**	
UPM-055	Input nozzle	UPM-055RF-INZ**	**=Wire diameter specs: φ0.5=05 φ0.5/φ0.6/φ0.8/φ1.0/φ1.2
	Center nozzle	UPM-055RF-CNZ**	
	Output nozzle	UPM-055RF-ONZ**	
UPM-055CC (Clean Cut Type)	Clean Cut roller unit	UPM-055CC-RU**	**=Wire diameter specs: φ0.6=06 φ0.5 ^{※3} /φ0.6/φ0.8/φ1.0/φ1.2
	Input nozzle	UPM-055CC-INZ**	
	Center nozzle	UPM-055CC-CNZ**	
	Output nozzle	UPM-055CC-ONZ**	

※1 Special Type
※3 Option: The 1 blade cutter for φ0.5

Solder Feed Spare Parts (Standard)

Product Image	Wire diameter	Needle ^{※4※6}	Needle holder	Tube set ^{※6}	Tube set length
	φ1.2	ND-15GP	CL-B-3	PT12-***	***=030...300mm ***=040...400mm ***=050...500mm ***=070...700mm ***=100...1000mm
	φ1.0	ND-16GP	CL-B-2	PT10-***	
	φ0.8	ND-17GP		PT08-***	
	φ0.6	ND-18GP		PT06-***	
	φ0.5	ND-19GP		PT05-***	
	φ0.4	ND-20GP		PT04-***	

※4 5 pcs per pack
※6 The model number differs for the clean cut type. Please make a separate inquiry.

Fill the length in ***

Solder Feed Spare Parts (Precision)

Product Image	Wire diameter	Precision needle ^{※5}	Nozzle adapter	Precision needle holder	Precision tube set	Tube set total length
	φ0.4	HND-0.5	NA04	CL-D-2	ST04-*****	***=15022...150mm
	φ0.3	HND-0.4	NA03	CL-D-1	ST03-*****	
	φ0.2	HND-0.3	NA02		ST02-*****	***=20022...200mm
	φ0.15	HND-0.2	NA01		ST015-*****	

※5 1pc per pack

Fill the length in ***

Solder Feed Spare Parts (High Accuracy)

Product Image	Wire diameter	Precision needle ^{※5※6}	Needle holder	Tube set ^{※6}	Tube set total length
	φ0.8	SND-10	CL-B-2	PT08-***	***=030...300mm ***=040...400mm ***=050...500mm ***=070...700mm ***=100...1000mm
	φ0.6	SND-08		PT06-***	
	φ0.5	SND-07		PT05-***	

※5 1pc per pack

※6 The model number differs for the clean cut type. Please make a separate inquiry.

Fill the length in ***

Lock-on Unit for Laser

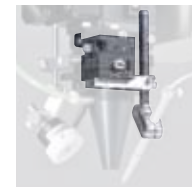
Product Image	Model No.	Solder preheating (○ = yes)	Solder supply angle
	LOL00-9020-XY		20°
	LOL00-9020H-XY	○	
	LOL00-9025-XY		25°
	LOL00-9025H-XY	○	
	LOL00-9030-XY		30°
	LOL00-9030H-XY	○	
	LOL00-9035-XY		35°
	LOL00-9035H-XY	○	
	LOL00-9040-XY		40°
	LOL00-9040H-XY	○	
	LOL00-9045-XY		45°
	LOL00-9045H-XY	○	
	LOL00-9050-XY		50°
	LOL00-9050H-XY	○	

*All lock-on mechanisms feature an XY regulation system. Also, a 90° head installation angle is standard.

EXTERNAL VIEW DIAGRAM

Laser Soldering Units

Unit : mm

Laser Head (F60 lens)

Soft Shutter

Side View

Straight On View

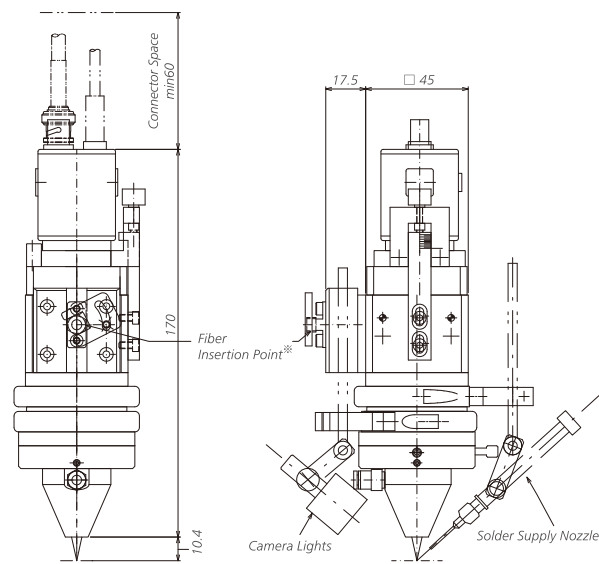

※Minimum Fiber Bending Radius: 200 mm

Mechanical Shutter

Side View

Straight On View

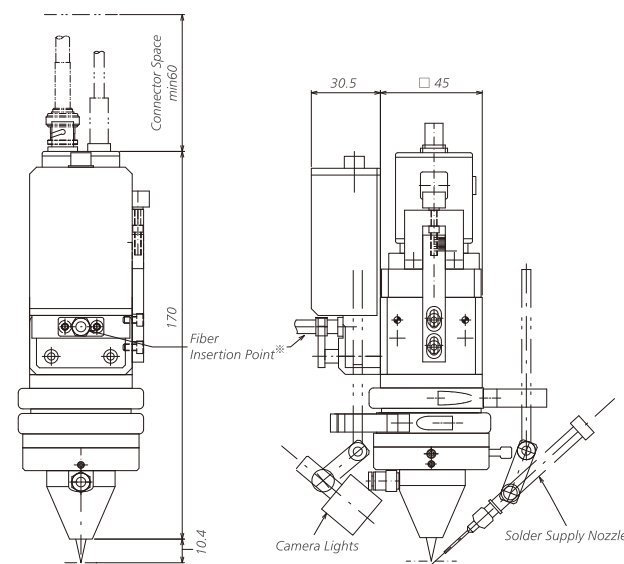

Laser Controller

Left Side View

Overhead View

Right Side View

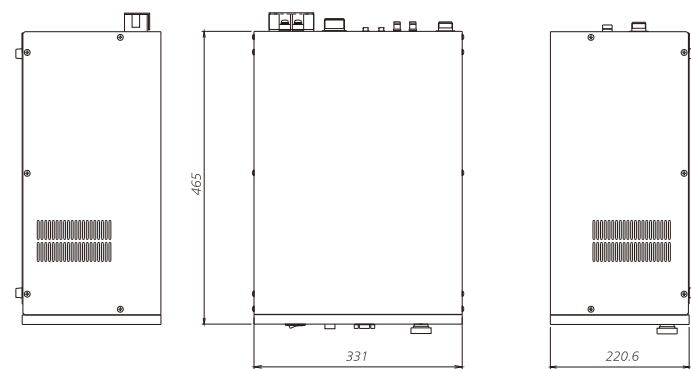

Straight On View

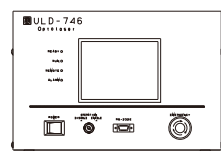

Laser Oscillator

Left Side View

Overhead View

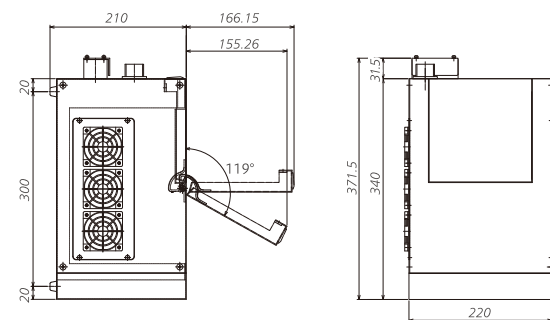

Straight On View



Desktop Laser Soldering Robot UNIX-413L

Unit : mm

Straight On View

Side View

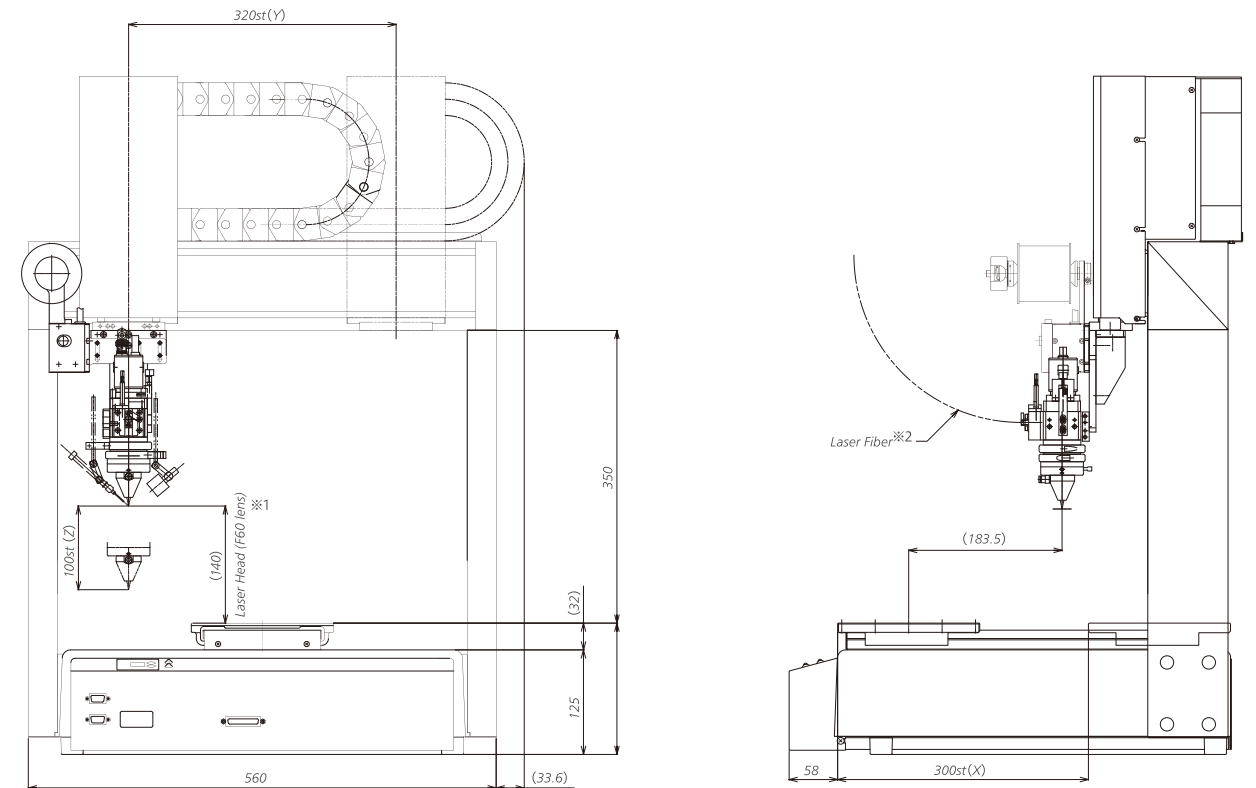

※1 Laser head (F60 lens) : about 140mm
Laser head (F80 lens) : about 120mm
Laser head (F100 lens) : about 100mm

※2 Minimum Fiber Bending Radius: 200 mm

Overhead View

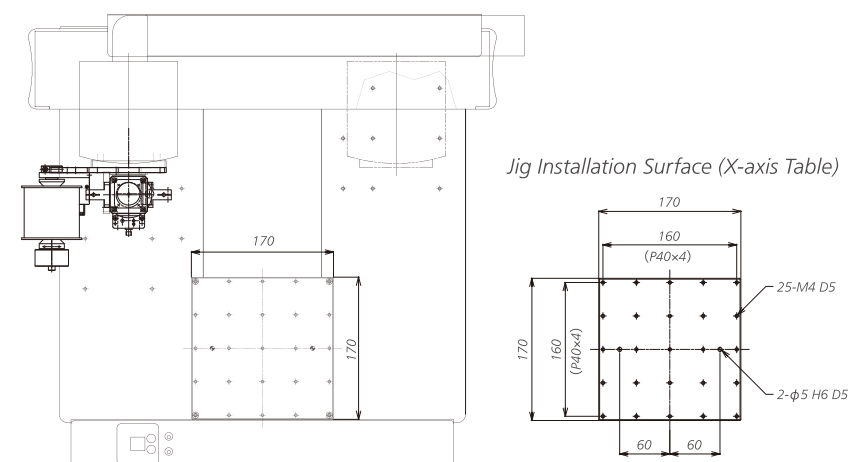

Comprehensive customer support structure provided by soldering engineers



Testing and Analysis Prior to Purchase

We preform soldering operation testing using systems that are identical to the ones the customer is considering for purchase. At Japan Unix we make maximum utilization of our soldering technology and experience to perform experiments, inspect results and only then suggest the ideal soldering structure and system.

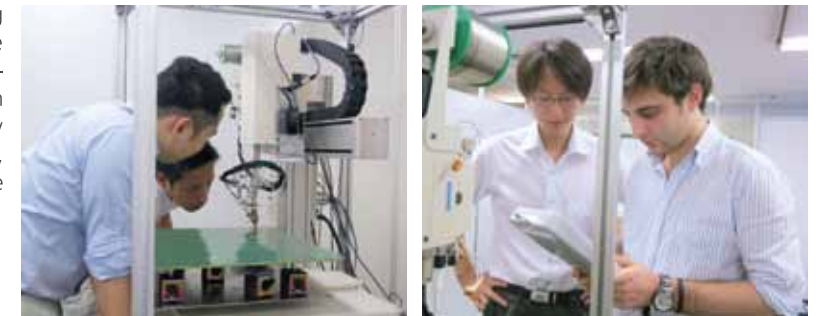

Design Support Service

In order to improve soldering operation efficiency and quality control, we provide a comprehensive range of processes from circuit board design to mass production.

Soldering Laboratory

The latest Japan Unix products are installed at our lab which is used for performing research and development of soldering technology, in addition to the testing procedures prior to purchase. It is also a place frequently used by worldwide customers, and has become something of an international soldering conference office. Also, in our soldering lab annex we analyze soldering joints in finer detail using state of the art optical and measurement systems. This plays a further role in the development of innovative products.



Soldering Support

In the manufacturing world, there is nothing more important than having someone you can trust when you run into unexpected trouble. The soldering specialist engineers at Japan Unix provide our customers with a comprehensive support structure from prior to your purchase to after the installation. This ensures continuous, safe, secure high quality manufacturing.

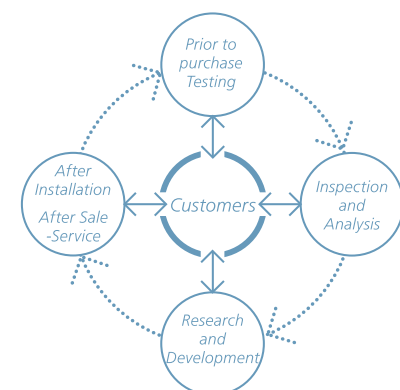

After-Service

To enable customers to operate in a more comfortable environment, we respond promptly to requests after the purchase for changes to system settings, software update, and repairs, among others. Please feel free to make an inquiry at any time.

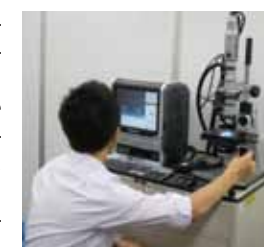

Soldering School (Certification Exam)

We regularly offer soldering classes which in a short period of time provide basic soldering techniques and knowledge.

※This program is based on The Japan Welding Engineering Society's "Micro-Soldering Technician Certification," and attendees can take the certification exam on the final day of the program.
 ※For more information, please contact the business supervisor or our school staff.





 Distributors

- North and Central America USA, Canada, Mexico
- Europe UK, Italy, Finland, France, Germany, Norway, Spain, Czech Republic, Slovakia, Hungary, Romania, Turkey
- Russia Saint Petersburg
- East Asia China (Shanghai, Suzhou, Beijing, Shenzhen, Chengdu, Chongqing, Xian, Hong Kong), S.Korea, Taiwan
- Southeast Asia Indonesia, Malaysia, Philippines, Singapore, Thailand
- Southern Asia India
- Oceania Australia
- Africa South Africa

 Japan Unix Offices

- Headquarters 2-21-25 Akasaka, Minato-ku, Tokyo 107-0052
TEL: +81-3-3588-0551 (Rep.) FAX: +81-3-3588-0554
- Osaka Office 3F, 3-27-27 Tarumi-cho, Suita-shi, Osaka 564-0062
TEL: +81-6-6190-4580 FAX: +81-6-6190-4581
- Nagoya Office 8F, 1-7-5 Kanayama-cho, Atsuta-ku, Nagoya-shi, Aichi 456-0002
TEL: +81-52-679-2111 FAX: +81-52-679-2112
- Techno Center 2020-3 Oaza Tabaru, Mashiki-machi,
Kamimashiki-gun, Kumamoto 861-2202
TEL: +81-96-287-4501 (Rep.) FAX: +81-96-287-4503
- Korea Office
- Shanghai Office
- Shenzhen Office
- Taiwan Office
- Malaysia Office
- Mexico Office