

TR7007QI SERIES

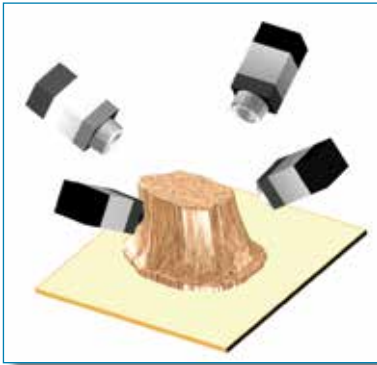

3D SOLDER
PASTE INSPECTION

TR7007QI FEATURES



Quad Digital Projectors Ensure Shadow-free Inspection

TR7007QI

Highly Accurate stop-and-go 3D SPI solution with latest TRI quad/dual digital projector shadow-free technology and inspection route optimization for enhanced inspection performance. Easy programming with innovative software bring maximum value to your production line.

Perfect Accuracy with Optimized Performance

TR7007QI employs TRI's latest 3D projector technology combined with advanced scanning path optimization to achieve best available inspection accuracy while maintaining competitive inspection speed. Choose optional CoaXPRESS upgrade for highest performance.

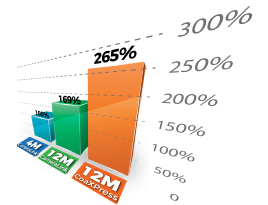

Achieve maximum performance with optional CoaXPRESS upgrade.

SPC



Statistical Report

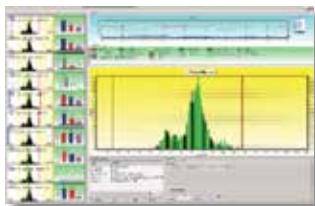

Multi-panel Histogram



Solder Height Distribution



3D Color Image

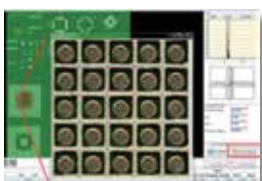

SPC 2D Real Image Query

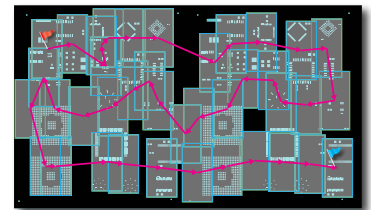
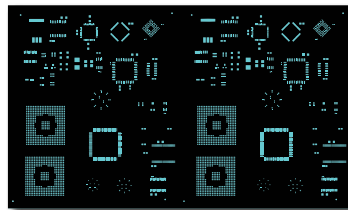

TRI's intelligent route optimization reduces the number of FOVs necessary to inspect every board, saving inspection cycle time.

Stable and Reliable Performance

Fully optimized for maximum stability, the TR7007QI delivers reliable inspection results 24 hours a day. Innovative SmartWarp technology automatically compensates for local board warpage and local fiducial marks help eliminate any impact of manufacturing tolerances.

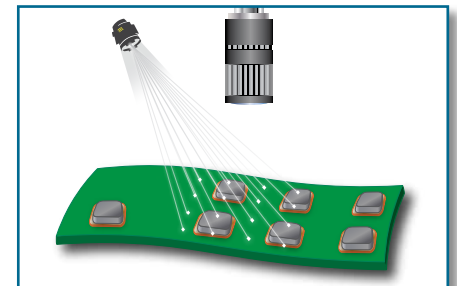
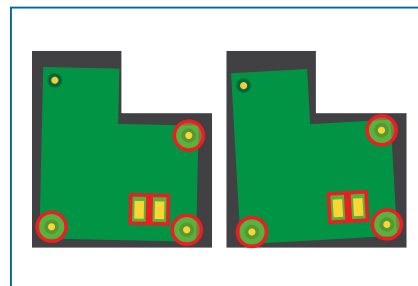

Unique Low Bridge Inspection

World's first inspection of low solder paste bridges under 30 μm ensures no printing defects are missed, and guarantees accurate results under any conditions.

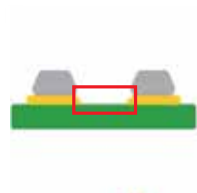

3D Height Profile cannot reveal low bridges

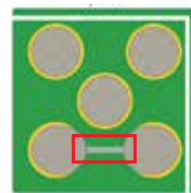

Top Color View



2D+3D Image with clear low bridge defect

Intuitive SPC Display

Full panel maps and real color images allow engineers to quickly monitor and diagnose problematic areas on the stencil, saving management time and reducing rework costs.

Intelligent Easy Programming Interface

Rapid intelligent 5-step programming interface ensures fast changeovers, minimal idle time and helps reduce operator work load.



Shadow Free Inspection Technology

Quad/Dual digital projector design and intelligent software ensure the TR7007QI delivers completely shadow-free inspection results and eliminates problems with specular reflections.

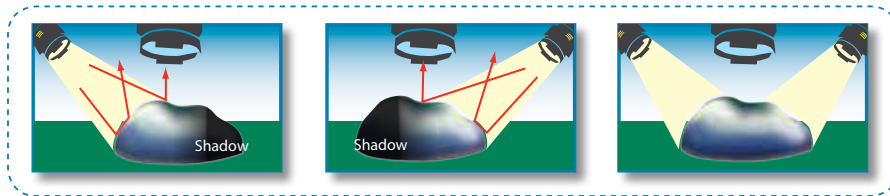

Multi-Color Vision for any PCB

Multi-phase color lighting guarantees accurate inspection results on any PCB color and finish combination, without sacrificing inspection speed.

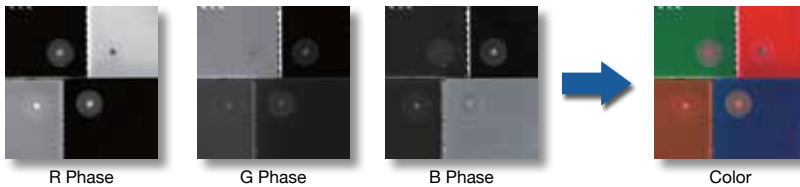

Yield Management System 4.0

YMS 4.0 provides real-time inspection status across SPI, AOI and AXI systems and monitors SPC and Alarm status, and supports remote fine-tune throughout the SMT line. The centralized inspection management provides top 5 to 10 defects and defective images, OEE review and management, issue and root cause drill down line by line, by station and by process, which improves quality and productivity analysis. YMS 4.0 supports Industry 4.0 initiative.

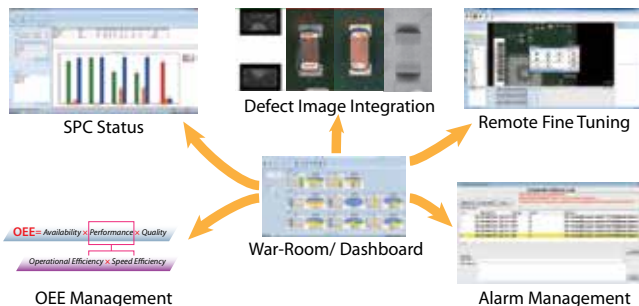

Closed Loop Function

TRI SPI systems share inspection results with connected SMT line equipment to help improve production yields and stabilize production quality while minimizing line stops and reducing production costs.

High Production Value = Maximum Cost Savings

- Industry Leading Inspection Speed
- Stable and Reliable Results
- Early Defect Detection
- Enhanced 100% Defect Coverage
- 98% Rework Cost Reduction

Yield Management System

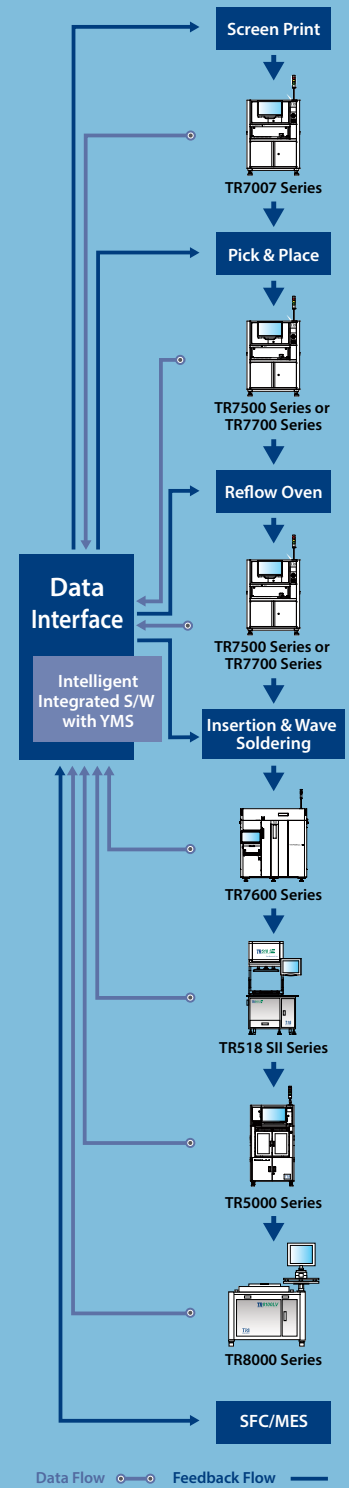

- Inspection results and data integration
- Real time SPC and production yield management
- Quality reports and closed loop tracking
- Support defect component analysis and improvements
- Knowledge Management (KM)
- Productivity and Quality Management

Optical & Imaging System

Camera Type	4 or 12 Mpix camera (factory setting)	
Optical Resolution	6 μ m or 10 μ m or 15 μ m (factory setting)	
3D Projection	Quad/Dual Digital Fringe Projectors	
Field of View	4 Mpix	12 Mpix
6 μ m	n/a	24.4 x 18.4mm (0.96 x 0.72 in.)
10 μ m	20.3 x 20.3mm (0.80 x 0.80 in.)	40.8 x 30.7mm (1.61 x 1.21 in.)
15 μ m	30.5 x 30.5mm (1.20 x 1.20 in.)	61.2 x 46.1mm (2.41 x 1.81 in.)

Inspection Functions

Defects Detected	Insufficient Paste, Excessive Paste, Shape Deformity, Missing Paste & Bridging
Measurement	Height, area, volume and offset

Inspection Speed

Camera Resolution	4 Mpix	12 Mpix Camera Link	12 Mpix CoaXPress*
Imaging Speed FOV/sec	3	2	3

* With optional CoaXPress upgrade

Inspection Performance

Volume Repeatability	Calibration Target (at 3 σ)	<1% on TRI calibration target
Height Repeatability	Calibration Target (at 3 σ) Solder GR&R (\pm 50% Tolerance)	<1% on TRI calibration target <<10% at 6 σ
Height Resolution	0.5 μ m	
Height Accuracy	1.5 μ m on calibration target	
Max. Solder Height	450 μ m (5 mm optional)	

Mechanical Stage

XY-axis ball screw with DSP-based motion controller	
XY Resolution	0.5 μ m with linear encoder
Z Resolution	0.5 μ m with linear encoder

PCB and Conveyor System

	TR7007QI	TR7007QI DL
Min. PCB Size	50 x 50 mm (1.97 x 1.97 in.)	
Max. PCB Size	510 x 460 mm* (20.1 x 18.1 in.)	510 x 310 mm x 2 lanes** (20.1 x 12.2 in. x 2 lanes) 510 x 590 mm x 1 lane** (20.1 x 23.2 in. x 1 lane)
PCB Thickness	0.6 - 5 mm (0.02 - 0.20 in.)	
PCB Transport Height	880 - 920 mm (34.6 - 36.2 in.)	
Max. PCB Weight	3 kg (6.61 lbs)	
PCB Carrier/Fixing	Belt/Pneumatic	
Clearance		
Top	25 mm	
Bottom	40 mm	
Edge	3 mm	

** For 6 μ m, the Max. PCB size is 330 x 310 mm

Dimensions

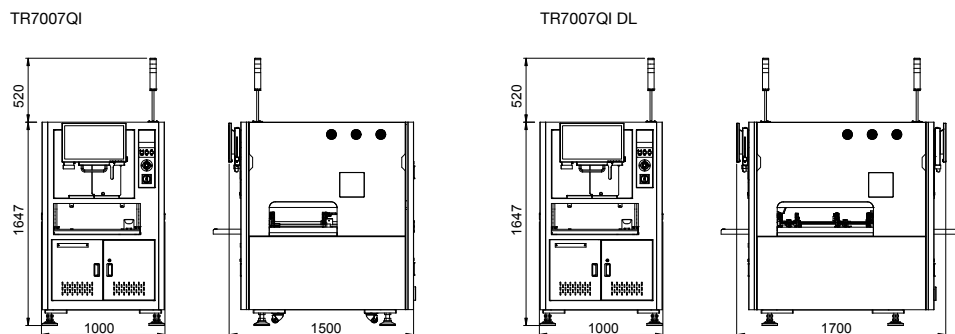

	TR7007QI	TR7007QI DL
Weight	675 kg (1489 lbs)	685 kg (1511 lbs)
Power Requirement	200 - 240 V, single phase, 50/60 Hz, 3 kVA	
Air Requirement	72 psi - 87 psi (5 - 6 Bar)	

Optional

SPC, Offline Editor, Gerber Tool, Barcode Scanner (linear & 2D) and Support Pins, Closed Loop Function, Yield Management System (YMS 4.0), YMS Lite, CoaXPress Camera Upgrade

Specifications are subject to change without notice. Content may not be used as acceptance criteria. All trademarks are the property of their owners.

TRI 德律 TRI INNOVATION

The absence of a product or service name or logo from this list does not constitute a waiver of TRI's trademark or other intellectual property rights concerning that name or logo. All other trademarks and trade names are the property of their owners.



Headquarters

7F., No.45, Dexing West Rd.,
Shilin Dist., Taipei City
11158, Taiwan
TEL: +886-2-2832-8918
FAX: +886-2-2831-0567
E-Mail: sales@tri.com.tw
http://www.tri.com.tw

Linkou, Taiwan

No.256, Huaya 2nd Rd.,
Guishan Dist., Taoyuan
County 33383, Taiwan
TEL: +886-2-2832-8918
FAX: +886-3-328-6579

Hsinchu, Taiwan

7F., No.47, Guangming 6th
Rd., Zhubei City, Hsinchu
County 30268, Taiwan
TEL: +886-2-2832-8918
FAX: +886-3-553-9786

Shenzhen, China

5F.3, Guangxia Rd.,
Shang-mei-lin Area,
Fu-Tian Dist., Shenzhen,
Guangdong, 518049, China
TEL: +86-755-83112668
FAX: +86-755-83108177
E-mail: shenzhen@cn.tri.com.tw

Suzhou, China

B Unit, Building 4, 78 Xinglin St.,
Suzhou Industrial Park,
215123, China
TEL: +86-512-68250001
FAX: +86-512-68096639
E-mail: suzhou@cn.tri.com.tw

Shanghai, China

Room 6C, Building 14,
470 Guiping Rd., Xuhui Dist.,
Shanghai, 200233, China
TEL: +86-21-54270101
FAX: +86-21-64957923
E-mail: shanghai@cn.tri.com.tw

USA

832 Jury Court, Suite 4,
San Jose, CA 95112 U.S.A
TEL: +1-408-567-9898
FAX: +1-408-567-9288
E-mail: triusa@tri.com.tw

Europe

O'Brien Strasse 14
91126 Schwabach
Germany
TEL: +49-9122-631-2127
FAX: +49-9122-631-2147
E-mail: trieurope@tri.com.tw

Japan

2-9-9 Midori, Sumida-ku,
Tokyo, 130-0021 Japan
TEL: +81-3-6273-0518
FAX: +81-3-6273-0519
E-mail: trijp@tri.com.tw

Korea

No.207 Daewoo-Technopia,
768-1 Wonsi-Dong, Danwon-Gu,
Ansan City, Gyeonggi-Do, Korea
TEL: +82-31-470-8858
FAX: +82-31-470-8859
E-mail: trikri@tri.com.tw

Malaysia

C11-1, Ground Floor, Lorong
Bayan Indah 3 Bay Avenue,
11900 Bayan Lepas Penang,
Malaysia
TEL: +604-6461171
E-mail: trimy@tri.com.tw